

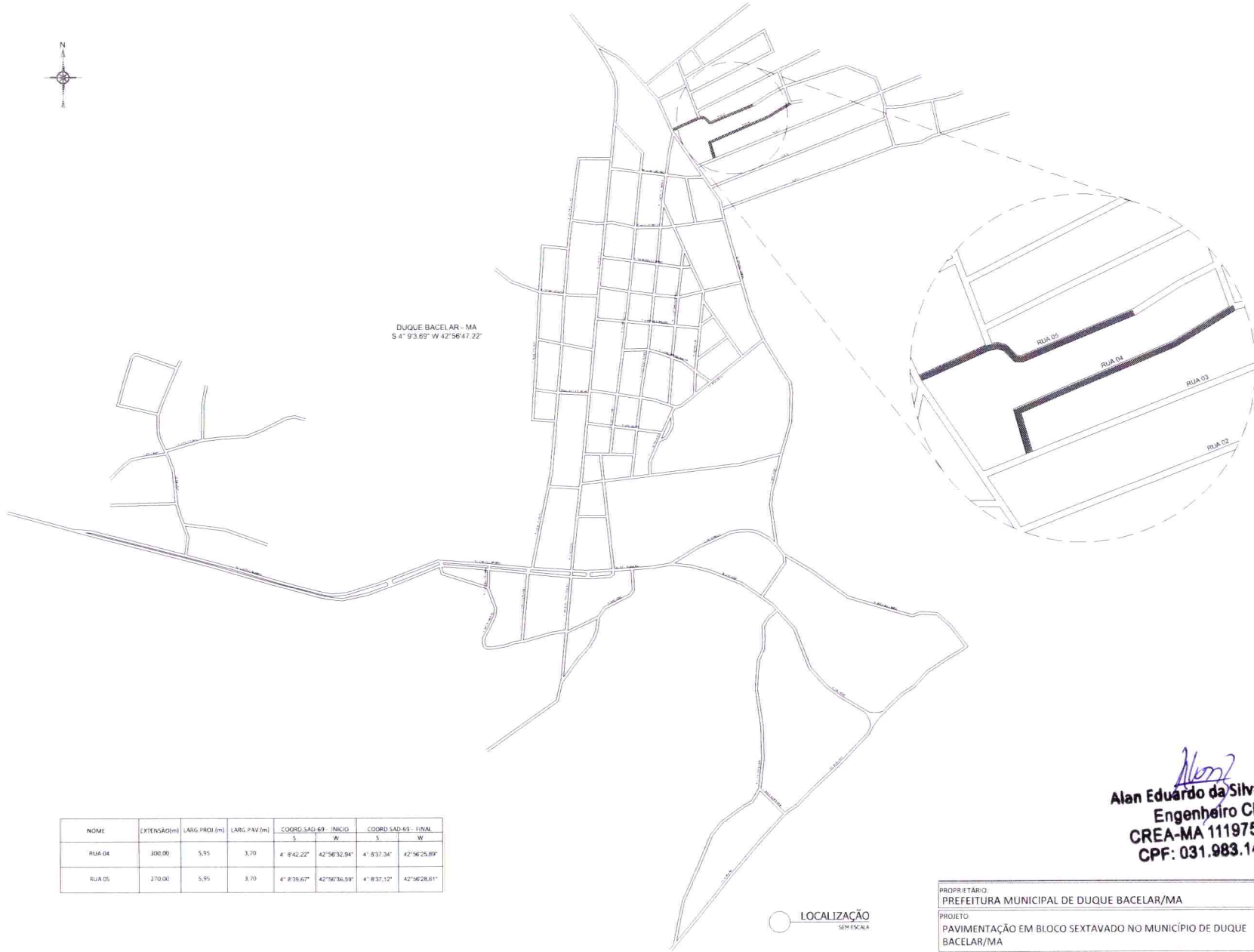



DUQUE BACELAR - MA
S 4° 9'3.69" W 42° 56'47.22"



NOME	EXTENSÃO(m)	LARG. PROJ.(m)	LARG. PAV.(m)	COORD. SAD. 69 - INÍCIO		COORD. SAD. 69 - FINAL	
				S	W	S	W
RUA 04	300.00	5,95	3,70	4° 8'42.22"	42°56'32.94"	4° 8'37.34"	42°56'25.89"
RUA 05	270.00	5,95	3,70	4° 8'38.67"	42°56'36.59"	4° 8'37.12"	42°56'28.61"

Alan
Alan Eduardo da Silva Borges
 Engenheiro Civil
 CREA-MA 111975192-6
 CPF: 031.983.143-48

LOCALIZAÇÃO
SEM ESCALA

PROPRIETÁRIO: PREFEITURA MUNICIPAL DE DUQUE BACELAR/MA	 FVSM <small>ENGENHARIA</small>
PROJETO: PAVIMENTAÇÃO EM BLOCO SEXTAVADO NO MUNICÍPIO DE DUQUE BACELAR/MA	
TÍTULO: LOCALIZAÇÃO	PRANCHA: 01/08
ESCALA:	DATA: MAI/2021



NOME	EXTENSÃO(m)	LARG. PROJ.(m)	LARG. PAV.(m)	COORD.SAD-69 - INICIO S W	COORD.SAD-69 - FINAL S W
RUA 04	300,00	5,95	3,70	4° 8'42,22"	42°56'32,94"
BUEIRO - BDTIC 0,90m	-	-	-	4° 8'46,16"	42°56'11,61"

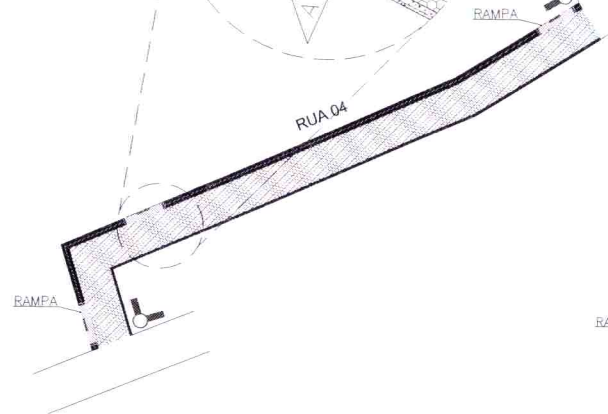
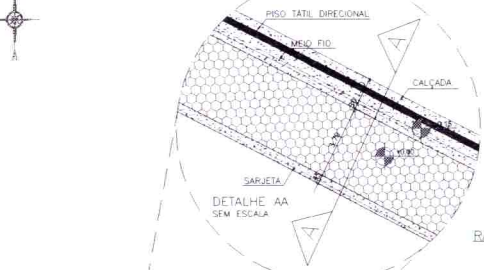

IMPLANTAÇÃO
SEM ESCALA

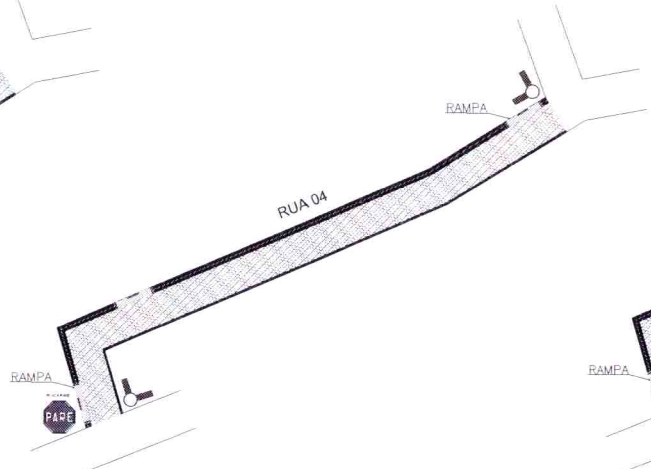

SINALIZAÇÃO VIÁRIA
SEM ESCALA

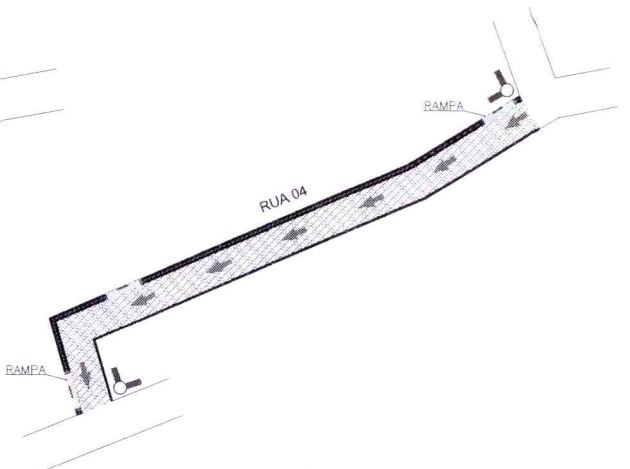

FLUXO DAS ÁGUAS
SEM ESCALA

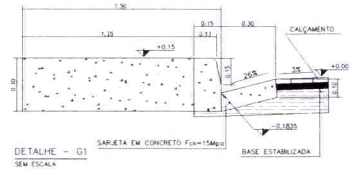

DETALHE - G1
SEM ESCALA

Seção Transversal

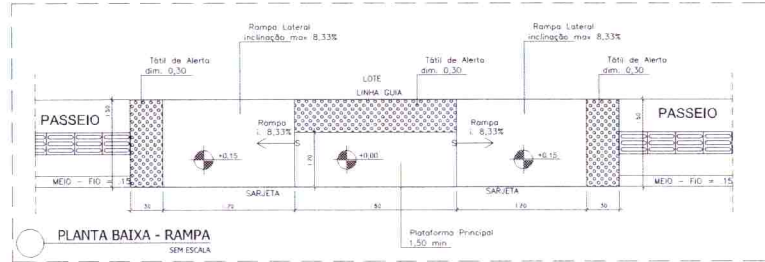
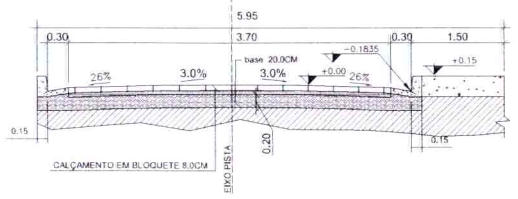

PLANTA BAIXA - RAMPA
SEM ESCALA

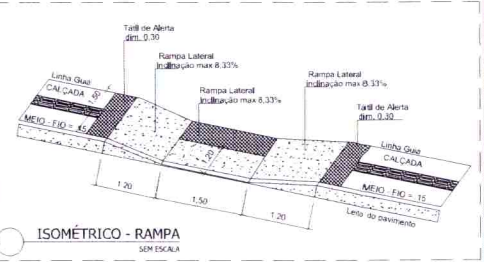

ISOMÉTRICO - RAMPA
SEM ESCALA

Alan?
Alan Eduardo da Silva Borges
 Engenheiro Civil
 CREA-MA 111975192-6
 CPF: 031.983.143-48

PROPRIETÁRIO: PREFEITURA MUNICIPAL DE DUQUE BACELAR/MA	
PROJETO: PAVIMENTAÇÃO EM BLOCO SEXTAVADO NO MUNICÍPIO DE DUQUE BACELAR/MA	
TÍTULO: IMPLANTAÇÃO, SINALIZAÇÃO VIÁRIA E FLUXO DAS ÁGUAS	PRANCHA: 02/08 ESCALA: DATA: MAI/2021

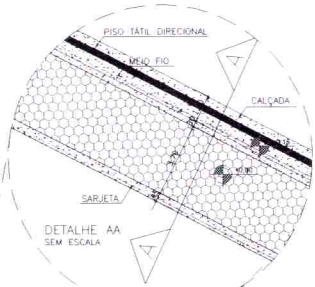

NOME	EXTENSÃO(m)	LARG. PROJ (m)	LARG. PAV (m)	COORD. SADO-99 - INÍCIO	COORD. SADO-99 - FINAL
				S W	S W
RUA 05	270,00	5,95	3,20	4° 8'13,61"	42°56'36,50"
BUERO - BDTC 0,80m	-	-	-	4° 8'16,80"	42°56'32,41"

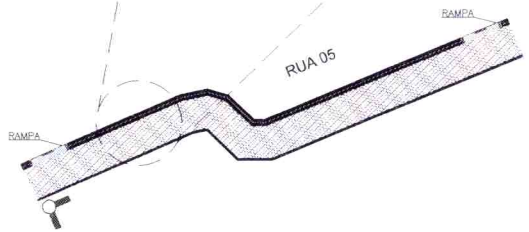

IMPLANTAÇÃO
SEM ESCALA

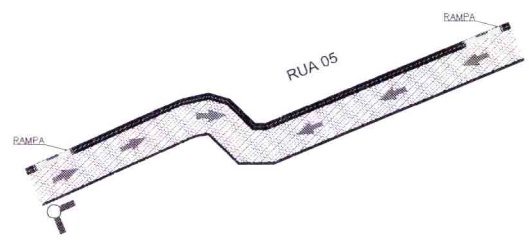

FLUXO DAS ÁGUAS
SEM ESCALA

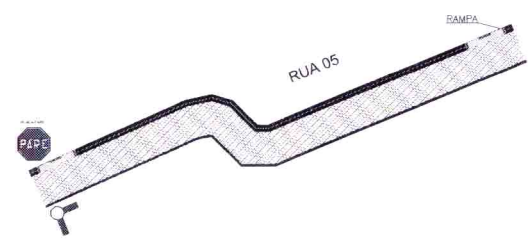

SINALIZAÇÃO VIÁRIA
SEM ESCALA

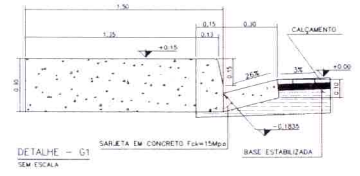

DETALHE - 01
SEM ESCALA

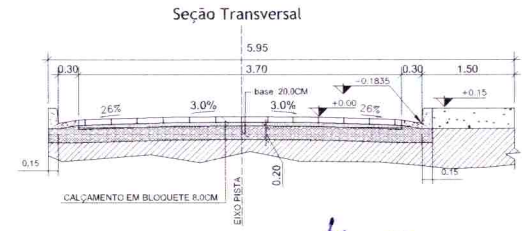

Seção Transversal

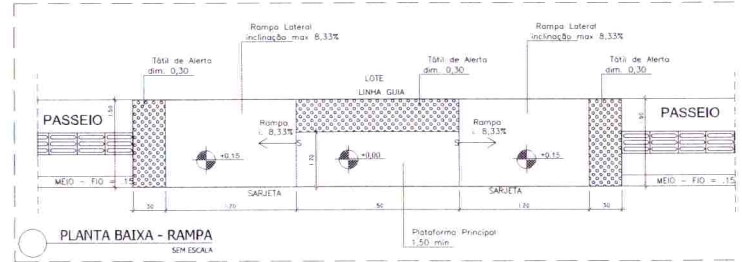

PLANTA BAIXA - RAMPA
SEM ESCALA

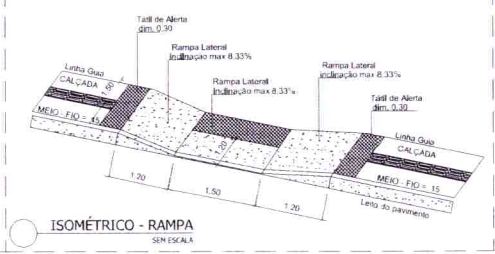

ISOMÉTRICO - RAMPA
SEM ESCALA

Alan
Alan Eduardo da Silva Borges
 Engenheiro Civil
 CREA-MA 111975192-6
 CPF: 031.983.143-48

PROPRIETÁRIO: PREFEITURA MUNICIPAL DE DUQUE BACELAR/MA		
PROJETO: PAVIMENTAÇÃO EM BLOCO SEXTAVADO NO MUNICÍPIO DE DUQUE BACELAR/MA		
TÍTULO: IMPLANTAÇÃO, SINALIZAÇÃO VIÁRIA E FLUXO DAS ÁGUAS	ESCALA:	DATA: MAI/2021
		PRANCHA: 03/08



BOTA FORA (2,0 KM)
S 4° 52' 14" W 42° 57' 32"

JAZIDA DE ATERRO (2,0 KM)
S 4° 46' 73" W 42° 57' 304"

MATERIAL DE DESMONTE: SAIBRO (ROCHA ALTERADA FORMADA POR MINÚSCULOS CRITAIS ARREDONDADOS)

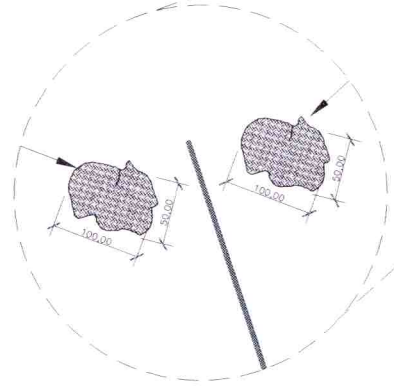

RUQUE BACELAR - MA
S 4° 53' 02" W 42° 56' 17,22"

IDENTIFICAÇÃO DE ÁREAS DE JAZIDA
SEM ESCALA

Alan
Alan Eduardo da Silva Borges
Engenheiro Civil
CREA-MA 111975192-6
CPF: 031.983.143-48

PROPRIETÁRIO: PREFEITURA MUNICIPAL DE DUQUE BACELAR/MA		
PROJETO: PAVIMENTAÇÃO EM BLOCO SEXTAVADO NO MUNICÍPIO DE DUQUE BACELAR/MA		
TÍTULO: IDENTIFICAÇÃO DE ÁREAS DE JAZIDA	ESCALA:	DATA: MAI/2021
		PRANCHA: 04/08

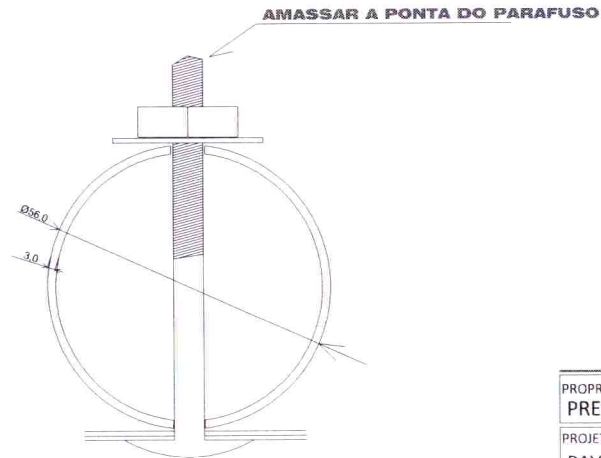
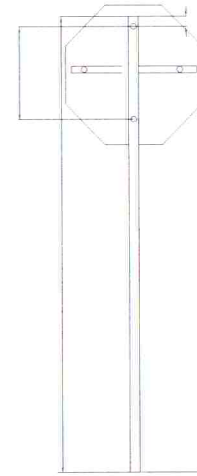
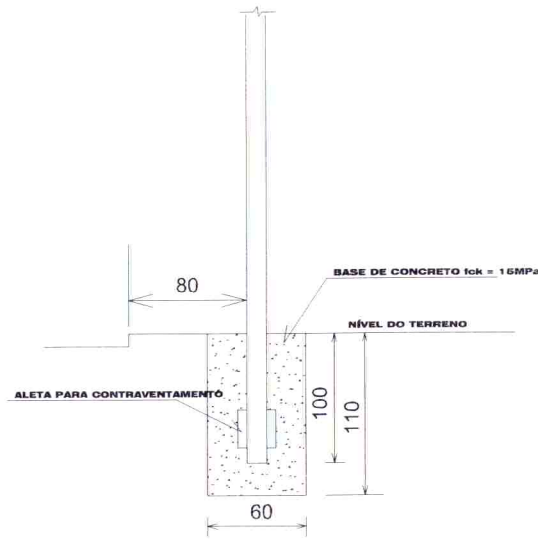
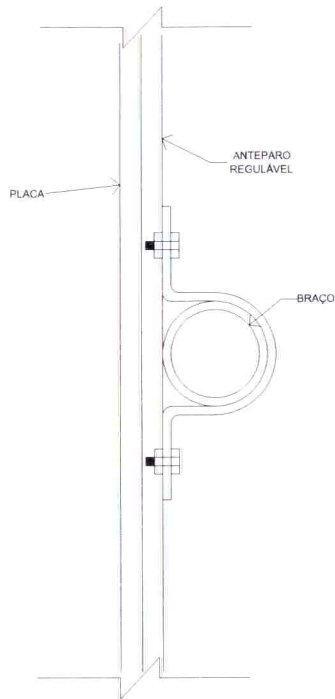

○ DETALHES
SEM ESCALA

Alon?
Alan Eduardo da Silva Borges
 Engenheiro Civil
 CREA-MA 111975192-6
 CPF: 031.983.143-48

PROPRIETÁRIO: PREFEITURA MUNICIPAL DE DUQUE BACELAR/MA		 FVSM <small>ESCRITÓRIO</small>
PROJETO: PAVIMENTAÇÃO EM BLOCO SEXTAVADO NO MUNICÍPIO DE DUQUE BACELAR/MA		
TÍTULO: DETALHES	ESCALA: INDICADA	DATA: MAI/2021 PRANCHA: 05/08

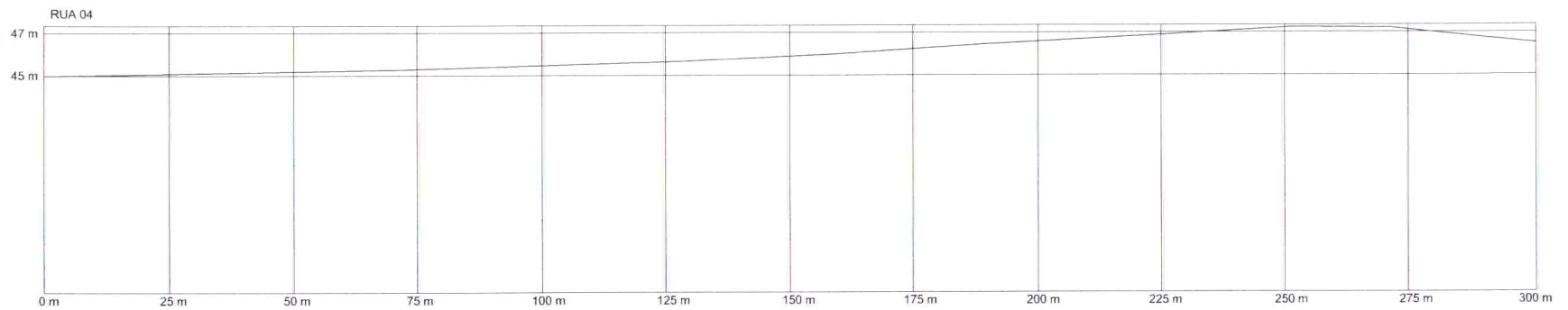
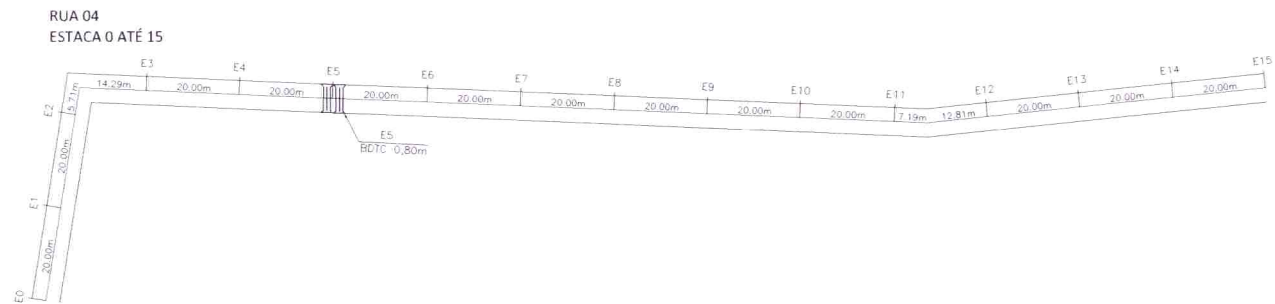

ESTAQUEAMENTO E PERFIL
SEM ESCALA

Alan Eduardo da Silva Borges
Engenheiro Civil
CREA-MA 111975192-6
CPF: 031.983.143-48

PROPRIETÁRIO:
PREFEITURA MUNICIPAL DE DUQUE BACELAR/MA

PROJETO:
PAVIMENTAÇÃO EM BLOCO SEXTAVADO NO MUNICÍPIO DE DUQUE
BACELAR/MA

TÍTULO:
ESTAQUEAMENTO E PERFIL

ESCALA:
INDICADA

DATA:
MAI/2021



PRANCHA: 06/08



RUA 05
ESTACA 0 ATÉ 13 + 10,00m

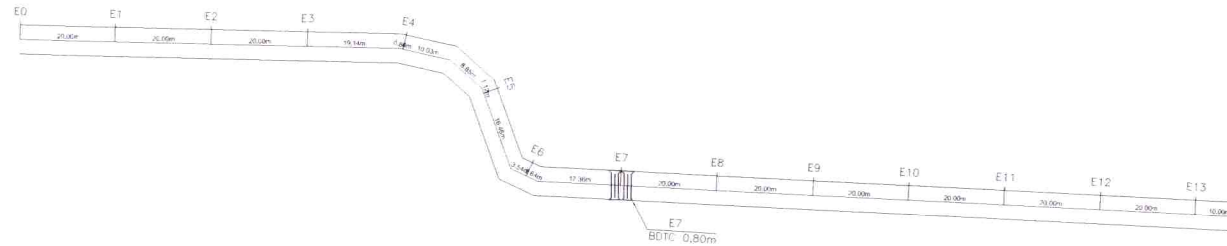

RUA 05

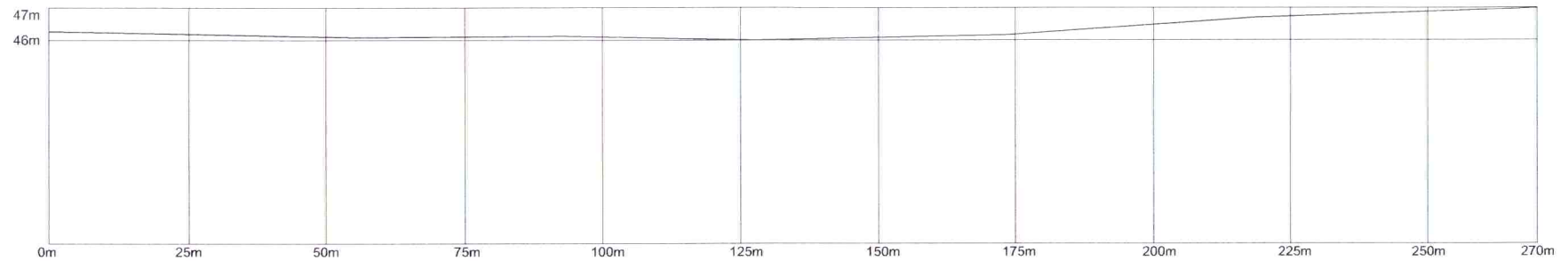

ESTAQUEAMENTO E PERFIL
SEM ESCALA

Alan Eduardo da Silva Borges
Engenheiro Civil
CREA-MA 111975192-6
CPF: 031.983.143-48

PROPRIETÁRIO:
PREFEITURA MUNICIPAL DE DUQUE BACELAR/MA

PROJETO:
PAVIMENTAÇÃO EM BLOCO SEXTAVADO NO MUNICÍPIO DE DUQUE
BACELAR/MA

TÍTULO:
ESTAQUEAMENTO E PERFIL

ESCALA:
INDICADA

DATA:
MAI/2021



PRANCHA: 07/08

BUEIRO DUPLO TUBULAR DE CONCRETO
 $D = 80\text{cm}$

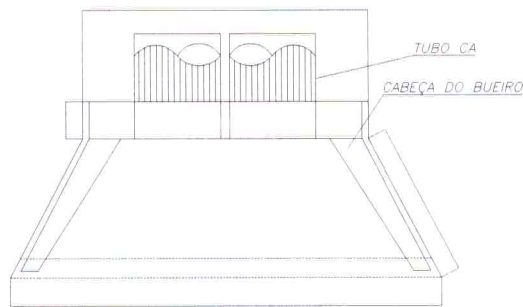

PLANTA BAIXA

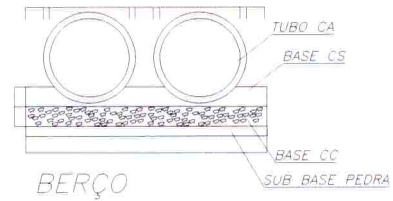

BERÇO

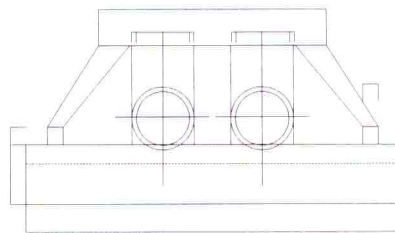

VISTA

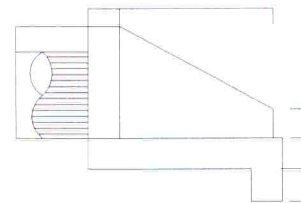

VISTA LATERAL

LEGENDA :

CA-CONCRETO ARMADO CA-1/CA-2 (DE ACORDO COM O FABRICANTE)

CS-CONCRETO SIMPLES CIAR/BR- 1,3,3

CC-CONCRETO CICLÓPICO CIAR/PB- 1:3 COM 70% PEDRA BRUTA

SUB-BASE-PEDRA BRUTA, TIPO "MATAÇÃO"

Alan Eduardo da Silva Borges
 Engenheiro Civil
 CREA-MA 111975192-6
 CPF: 031.983.143-48

PROPRIETÁRIO:
 PREFEITURA MUNICIPAL DE DUQUE BACELAR/MA

DISCRIMINAÇÃO:
 PAVIMENTAÇÃO EM BLOCO SEXTAVADO NO MUNICÍPIO DE DUQUE
 BACELAR/MA

TÍTULO:
 DETALHE DOS BUEIROS

ESCALA:
 INDICADA

DATA:
 MAI/2021



PRANCHA: 08/08